

產品設計導向分析軟體

# 生醫工程實例

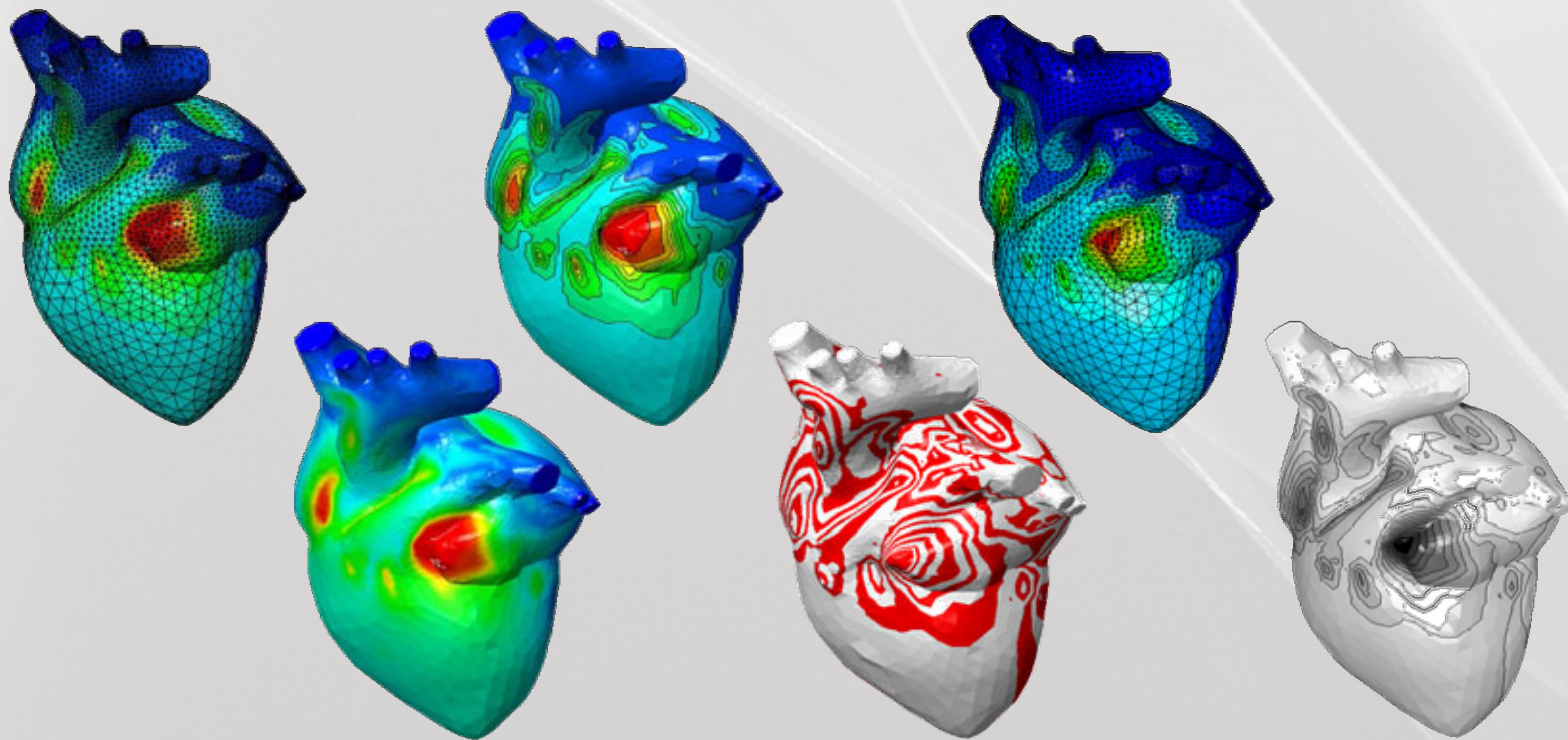

midas NFX

midas **NFX**

## 一 分析模型

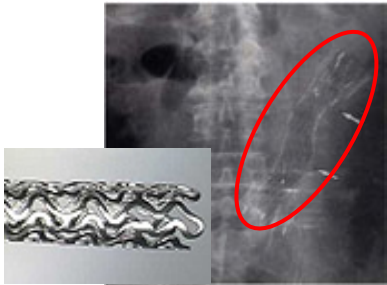

## 強度分析

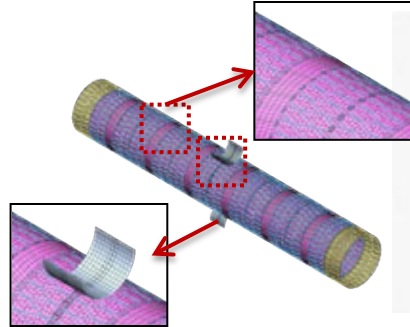

## 形狀



## 應力分佈

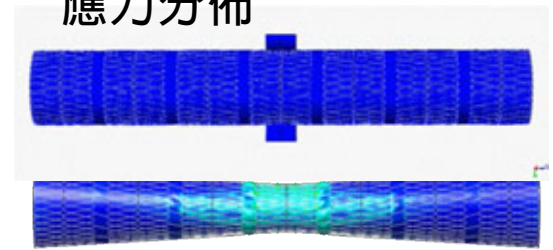

## 疲勞分析

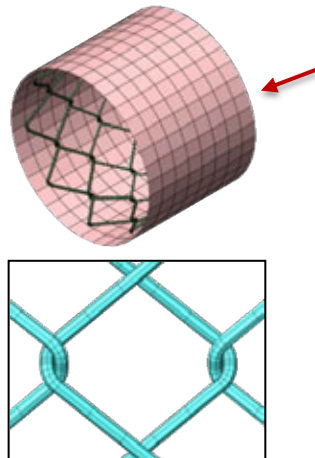

長期使用模型使用壽命評估

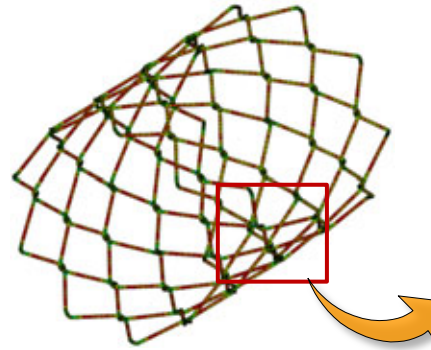

## 應力分佈

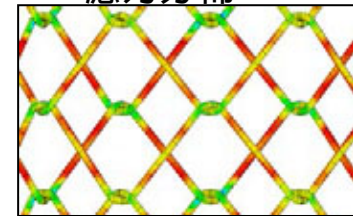

## 生命週期疲勞壽命

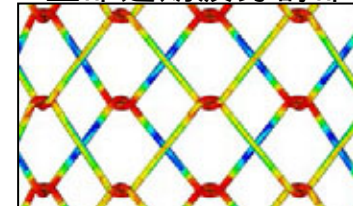

midas **NFX**

## 一 分析模型

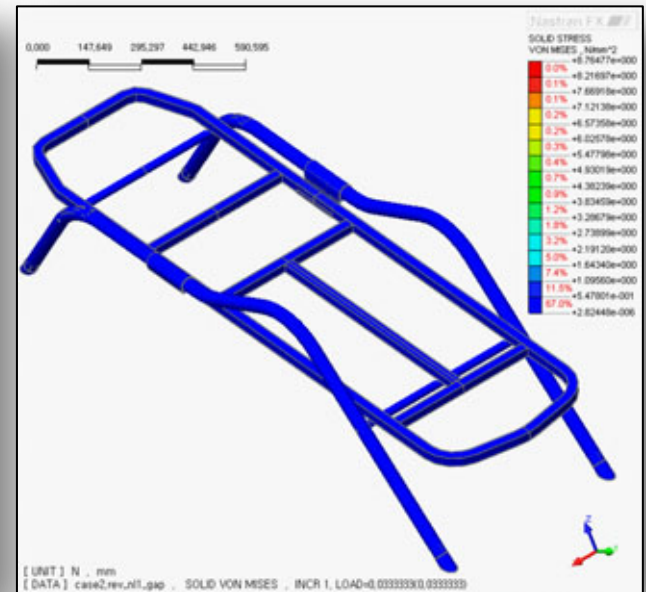
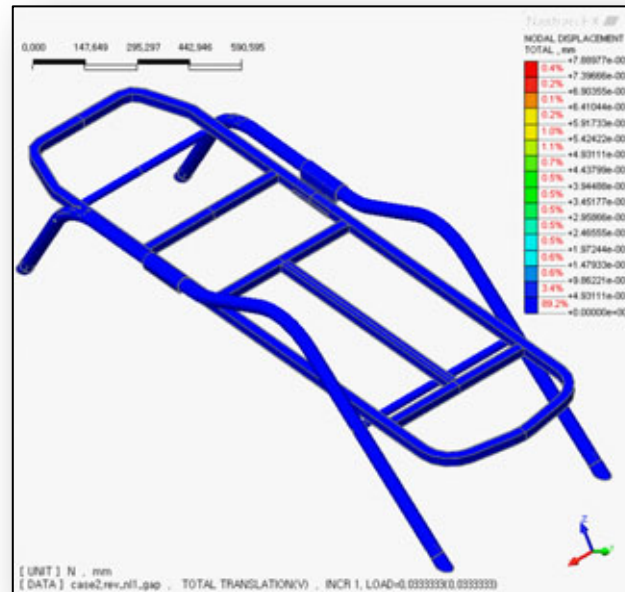
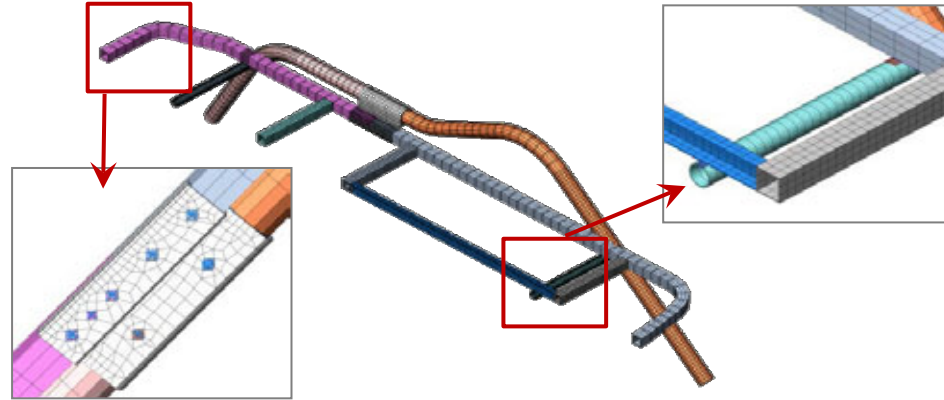

# 升降機可靠性評估(結構/簡諧)

midas **NFX**

## 線性靜態分析

最大變形量4.7mm

最大應力65MPa

## 一分析模型

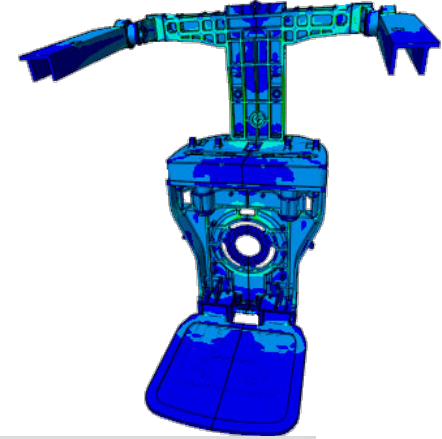
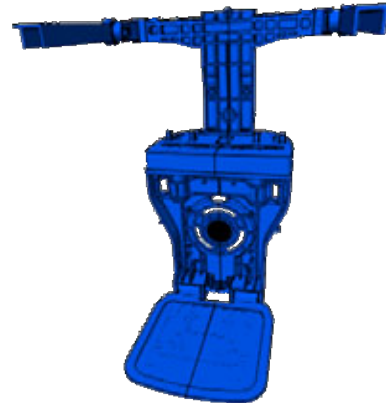
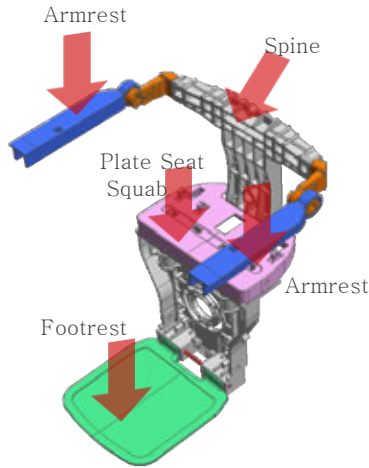

## 簡諧響應分析

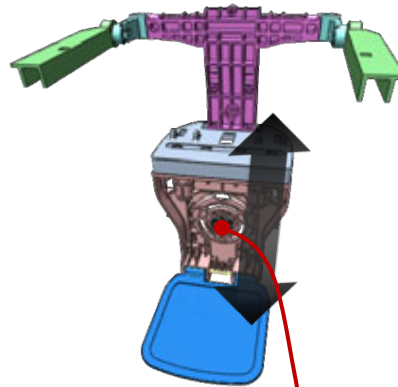

週期重複性的工作負荷

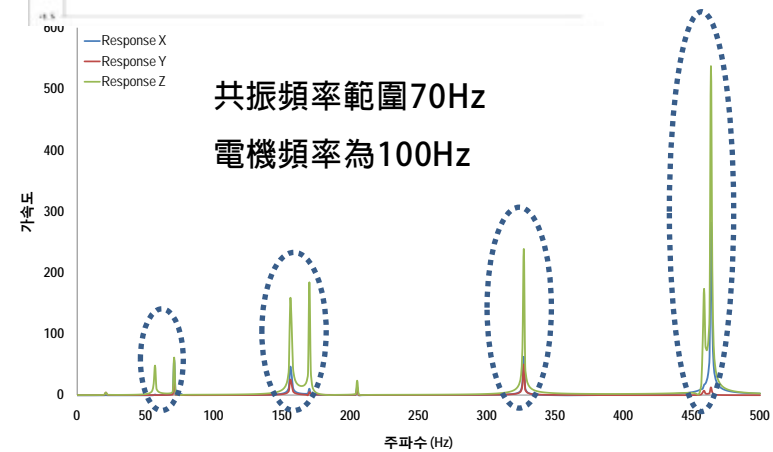
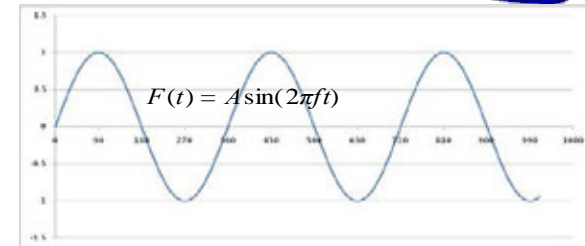

# 升降機可靠性評估(疲勞/瞬態響應)

midas **NFX**

## 疲勞分析

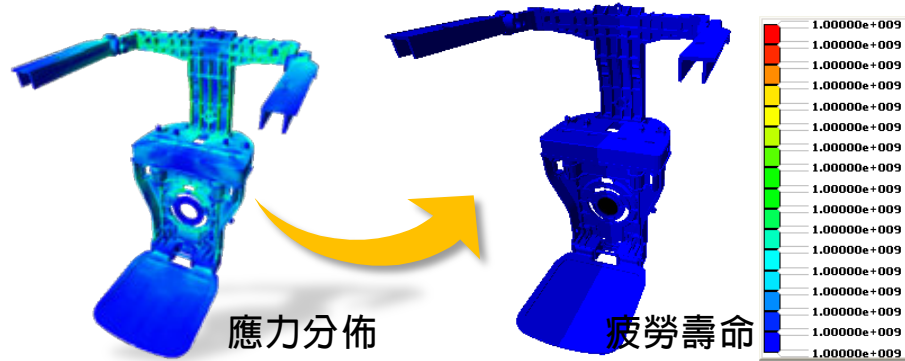

## S-N曲線

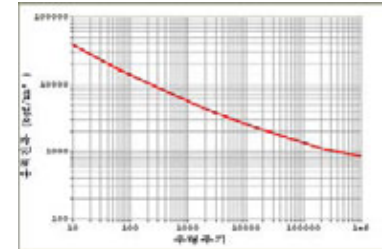

## 一分析模型



## 瞬態響應分析

